

GARMIN®

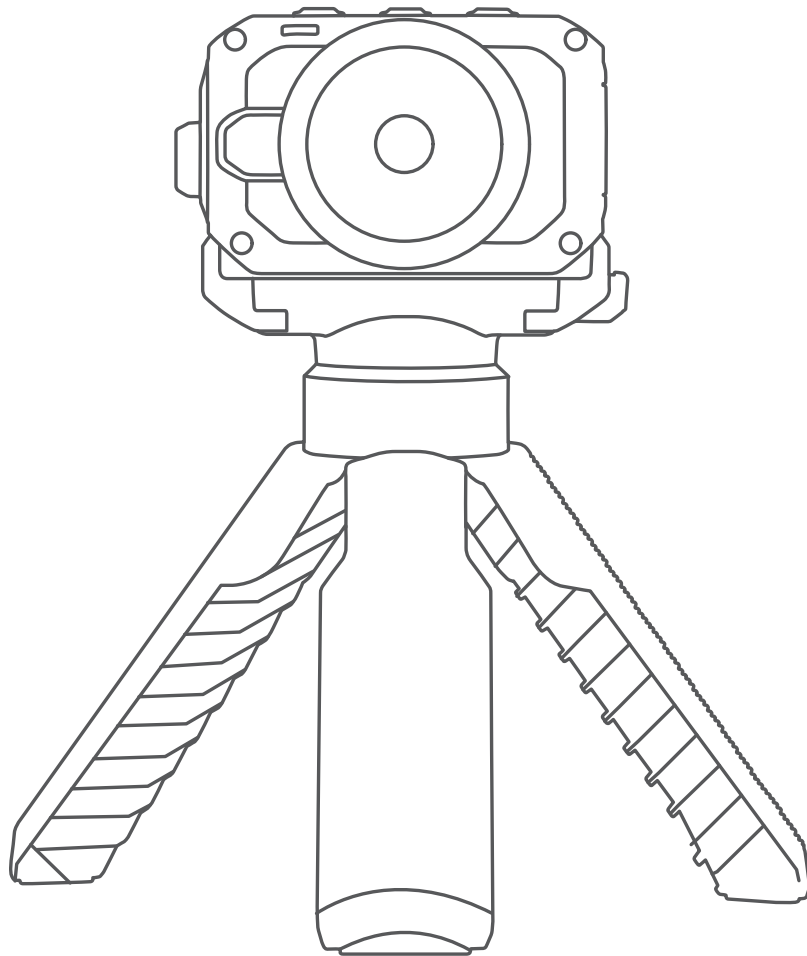

VIRB[®] 360

Owner's Manual

© 2017 Garmin Ltd. or its subsidiaries

All rights reserved. Under the copyright laws, this manual may not be copied, in whole or in part, without the written consent of Garmin. Garmin reserves the right to change or improve its products and to make changes in the content of this manual without obligation to notify any person or organization of such changes or improvements. Go to www.garmin.com for current updates and supplemental information concerning the use of this product.

Garmin®, the Garmin logo, ANT+®, fēnix®, and VIRB® are trademarks of Garmin Ltd. or its subsidiaries, registered in the USA and other countries. G-Metrix™ is a trademark of Garmin Ltd. or its subsidiaries. These trademarks may not be used without the express permission of Garmin.

Android™, Google™, Google Cardboard™, and YouTube™ are trademarks of Google Inc. Apple® and Mac® are trademarks of Apple Inc., registered in the U.S. and other countries. The Bluetooth® word mark and logos are owned by the Bluetooth SIG, Inc. and any use of such marks by Garmin is under license. Facebook™ and the Facebook logo are trademarks of Facebook and its affiliate companies. HDMI® is a registered trademark of HDMI Licensing, LLC. microSD® and the microSDXC logo are trademarks of SD-3C, LLC. Wi-Fi® is a registered mark of Wi-Fi Alliance Corporation. Windows® is a registered trademark of Microsoft Corporation in the United States and other countries. Other trademarks and trade names are those of their respective owners.

This product is ANT+® certified. Visit www.thisisant.com/directory for a list of compatible products and apps.

Table of Contents

| | |
|--|-----------|
| Introduction | 1 |
| Camera Controls..... | 1 |
| Device Overview..... | 1 |
| Installing the Battery..... | 1 |
| Installing a Memory Card..... | 1 |
| Charging the Battery..... | 1 |
| Turning On the Camera..... | 2 |
| Turning Off the Camera..... | 2 |
| Turning the Camera On and Off Using the Recording Switch..... | 2 |
| Home Screen Overview..... | 2 |
| Status Bar Icons..... | 2 |
| Main Menu..... | 2 |
| Camera Mounts | 3 |
| Assembling the Tripod and Cradle..... | 3 |
| Assembling the Action Cradle and Mounts..... | 3 |
| Removing the Camera from the Cradle..... | 3 |
| Video | 4 |
| Preparing to Record a Video..... | 4 |
| Tips for Shooting 360-degree Video..... | 4 |
| Recording a Video..... | 4 |
| Lens Modes..... | 4 |
| Changing the Stitching Distance..... | 4 |
| Video Modes..... | 4 |
| Recording a Time-Lapse Video..... | 4 |
| Video Mode Specifications..... | 5 |
| Slo-Mo Mode Specifications..... | 5 |
| Time-Lapse Mode Specifications..... | 5 |
| Microphone Modes..... | 5 |
| Planar Spatial Audio..... | 5 |
| Outputting Live Video to an External Device..... | 5 |
| Photos | 5 |
| Taking Photos..... | 5 |
| Setting the Default Photo Self Timer..... | 5 |
| Photo Modes..... | 6 |
| Voice Control | 6 |
| Setting Up Voice Control..... | 6 |
| Controlling the Camera Using Voice Commands..... | 6 |
| Voice Control Commands..... | 6 |
| Voice Control Tips..... | 6 |
| G-Metrix | 6 |
| G-Metrix Data..... | 6 |
| Garmin VIRB App | 7 |
| Connecting to the Garmin VIRB App Using NFC..... | 7 |
| Connecting to the Garmin VIRB App Using Wi-Fi Settings..... | 7 |
| Remote Viewfinder..... | 7 |
| Pro Settings..... | 8 |
| Recording a Video Using the Garmin VIRB App..... | 8 |
| Taking a Photo Using the Garmin VIRB App..... | 8 |
| Broadcasting Live Video..... | 8 |
| App and Camera Settings..... | 8 |
| Photo Exposure Types..... | 9 |
| Recording 5.7K RAW Video..... | 9 |
| Recording a Video Loop..... | 9 |
| Time-Lapse Photos and Video..... | 10 |
| Garmin VIRB App Gallery..... | 11 |
| Viewing a Photo or Video..... | 11 |
| Using Virtual Reality (VR) Viewing Mode..... | 11 |
| Editing and Sharing a Video..... | 11 |
| Connecting to a Wi-Fi Network..... | 11 |
| Turning the Wi-Fi Radio On or Off..... | 12 |
| Changing the Wi-Fi Connection..... | 12 |
| Forgetting a Wi-Fi Network..... | 12 |
| Multiple Camera Network..... | 12 |
| Setting Up a Camera Network..... | 12 |
| Adding a Camera to the Network..... | 12 |
| Switching Cameras..... | 13 |
| Remote Control | 13 |
| Controlling Your VIRB Camera Remotely..... | 13 |
| Controlling Multiple VIRB Cameras..... | 13 |
| Enabling the Remote Wake Up Feature..... | 13 |
| ANT+ Sensors | 14 |
| Pairing ANT+ Sensors..... | 14 |
| Removing Paired ANT+ Sensors..... | 14 |
| Bluetooth Devices | 14 |
| Connecting a Wireless External Microphone..... | 14 |
| Connecting an OBD-II Device..... | 14 |
| Removing Paired Bluetooth Devices..... | 14 |
| VIRB Edit | 14 |
| Customizing the Device | 14 |
| Setup Menu..... | 14 |
| Formatting Your Memory Card..... | 14 |
| System Settings..... | 14 |
| Device Information | 15 |
| Status LEDs..... | 15 |
| Connecting Directly to a Wi-Fi Network Using WPS..... | 15 |
| Garmin Support Center..... | 15 |
| Software Updates..... | 15 |
| Updating the Camera Software Using the Garmin VIRB App..... | 15 |
| Updating the Software with Garmin Express..... | 15 |
| Specifications..... | 16 |
| Low Temperature Performance Tips..... | 16 |
| Viewing Regulatory and Compliance Information..... | 16 |
| Device Care..... | 16 |
| Water Exposure and Rating..... | 17 |
| Cleaning the Device..... | 17 |
| Replacing a Cover Lens..... | 17 |
| Symbol Definitions..... | 17 |
| Troubleshooting | 17 |
| My camera does not turn on..... | 17 |
| My camera feels warm while it is operating..... | 17 |
| Some G-Metrix data is missing..... | 17 |
| My video recordings do not look smooth..... | 18 |
| My device turns off when I stop recording video..... | 18 |
| Extending the Battery Life..... | 18 |
| Index | 19 |

Introduction

⚠ WARNING

See the *Important Safety and Product Information* guide in the product box for product warnings and other important information.

It is your responsibility to use the device in a safe manner. Garmin® will not be responsible for any property damage, injuries or deaths resulting from any use of this device in any activities.

Camera Controls



| Item | Name | Description |
|------|------------------|---|
| ① | POWER | Select to scroll through menus and menu items. Hold to turn the device on or off. |
| ② | OK | From the home screen, select to take a photo. From the home screen, hold to set the photo delay timer. From a menu, select to choose a menu item. |
| ③ | WI-FI | Select to scroll through menus and menu items. Hold to turn the Wi-Fi® radio on or off. |
| ④ | Recording switch | Move the switch to start or stop recording video (<i>Recording a Video</i> , page 4). |

Device Overview



| Item | Camera Part | Description |
|------|-------------------|--|
| ① | Status LEDs (2) | Indicate status information about the camera and features (<i>Status LEDs</i> , page 15). |
| ② | Front camera lens | Captures the front half of the video sphere. By default, the starting view for 360-degree videos is centered on this lens. |
| ③ | Rear camera lens | Captures the rear half of the video sphere. |
| ④ | Microphones (4) | Capture 360-degree spatial audio. |

Installing the Battery

⚠ WARNING

This product contains a lithium-ion battery. To prevent the possibility of personal injury or product damage caused by battery exposure to extreme heat, store the device out of direct sunlight.

- 1 Slide the latch ① to open the battery compartment door.



- 2 Insert the battery ② into the compartment.
- 3 Close the battery compartment door, and press it until it clicks.

Installing a Memory Card

You must install a compatible microSD® memory card to use your device. You should use a UHS-I microSD card from a quality manufacturer with a speed class rating of U3 or better and a storage capacity of up to 128 GB. For more information about compatible memory cards, go to garmin.com/VIRBcards.

- 1 Slide the latch ① to open the side door.



- 2 Insert the memory card ② into the slot, and press it in until it clicks.
- 3 Close the door, and press it until it clicks.

Charging the Battery

The status LEDs flash rapidly when the battery charge level is low. You can charge the battery using a standard wall outlet or a USB port on your computer. The camera is powered by a removable lithium-ion battery.

TIP: The optional external battery charger accessory allows you to charge up to two batteries outside the camera. Go to garmin.com/virb to purchase the battery charger accessory and spare batteries.

NOTE: The battery will not charge when outside the approved charging temperature range (*Specifications*, page 16).

- 1 Turn off the camera.

The camera **does not** charge the battery while it is turned on. It is possible to operate the camera using external power, but the battery charge level does not increase until you turn off the camera.

- Slide the latch ① to open the side door.

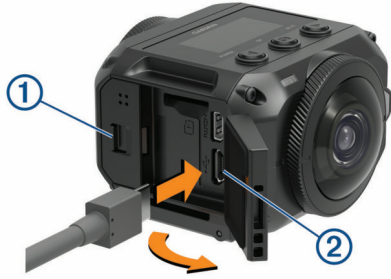

- Plug the small end of the USB cable into the micro-USB port ② on the camera.

NOTICE

Use only the included micro-USB cable or another cable with a straight micro-USB connector. Do not use a micro-USB cable with an right-angle connector. A right-angle connector may cause damage to the recessed micro-USB port.

- Plug the large end of the USB cable into a USB wall charger or a computer USB port.

NOTE: For the best results, a USB wall charger that provides at least a 2 A power output is recommended. Many USB power adapters for smartphones or tablets may be compatible.

When you connect the device to a power source, one status LED ③ turns solid red.



- Charge the battery.

It takes approximately two hours to charge the battery to 80% capacity, and approximately three hours to fully charge the battery. When the battery is fully charged, the red status LED turns off.

Turning On the Camera

Hold **POWER**.

The status LEDs flash green when the camera is on.

Turning Off the Camera

NOTICE

To prevent loss of data, always turn off the camera before removing the battery.

NOTE: You cannot turn off the camera while recording video.

- If necessary, move the recording switch backward to stop recording video.
- Hold **POWER**.

The camera saves your data and turns off.

If you need to remove the battery, wait until the screen and status LEDs turn off before removing the battery.

Turning the Camera On and Off Using the Recording Switch

You can use the recording switch to turn the camera on and immediately start recording video. If you turn the camera on using the recording switch, it turns off automatically when you stop the recording using the recording switch. This feature allows you to start and stop recording quickly, while automatically turning off the camera to conserve battery power when you are not recording.

NOTE: The camera does not turn off using the recording switch unless you use the recording switch to turn it on.

- With the device turned off, move the recording switch forward.
The device turns on and starts recording video.
- When you are finished recording, move the recording switch backward.
The device stops recording and turns off.

Home Screen Overview

The home screen provides at-a-glance details about the remaining memory card space and current settings of your device.

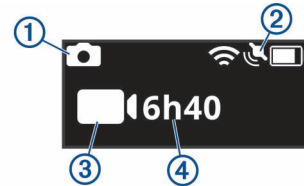

| | |
|---|--|
| ① | Displays the photo mode. |
| ② | Displays the sensor status and remaining battery capacity. Includes ANT+® sensors, Bluetooth®, Wi-Fi, and GPS. |
| ③ | Displays the video mode. |
| ④ | Displays the remaining memory card space for video recording. |

Status Bar Icons

Icons appear at the top of the home screen.

- A flashing icon means the device is searching for a signal.
- A solid icon means the signal is acquired or the wireless device is connected.

| | |
|--|-----------------------------|
| | GPS status |
| | Wi-Fi technology status |
| | Bluetooth technology status |
| | ANT+ sensor status |
| | Battery level |

Main Menu

From the home screen, select ◀ or ▶ to scroll through the main menu.

Video Mode: Sets the video shooting mode ([Video Modes, page 4](#)).

Photo Mode: Sets the photo shooting mode ([Photo Modes, page 6](#)).

Lens Mode: Enables one or both lenses, and sets the field of view ([Lens Modes, page 4](#)).

Wireless: Allows you to connect to other devices, including mobile devices, Bluetooth microphones and sensors, ANT+ sensors, and compatible Garmin devices and remotes.

Setup: Allows you to set up camera features, change system settings, and view system information ([Setup Menu, page 14](#)).

Camera Mounts

Assembling the Tripod and Cradle

You can use the universal tripod cradle to attach the camera to the included tripod or a standard camera tripod.

- 1 Screw the tripod into the threaded hole in the bottom of the tripod cradle.



- 2 Place one side of the camera into the cradle, fitting the grooves in the side of the camera onto the teeth.



- 3 Press the other side of the camera down until it clicks.
- 4 Select an option:
 - To shoot handheld video, keep the tripod legs closed. The tripod operates as a handheld grip when the legs are closed.
 - To shoot video from a stationary location, open the tripod legs and place the camera at the shooting location.



Assembling the Action Cradle and Mounts

You can use the included action cradle to attach your camera to compatible VIRB action camera mounting accessories (not

included). Go to garmin.com/virb to purchase mounting accessories.

- 1 Place one side of the camera into the cradle, fitting the grooves in the side of the camera onto the teeth.



- 2 Press the other side of the camera down until it clicks.
- 3 Place the flanges on the bottom of the action cradle into the compatible mount (not included), and secure the cradle with a thumbscrew.



NOTE: Some mounting accessories may use a different method to secure the camera to the mount. See the instructions included with the mounting accessory for more information.

Removing the Camera from the Cradle

- 1 Press the button ① to open the cradle.



TIP: Avoid squeezing or obstructing the sliding portion of the cradle ② when you press the button.

- 2 Tilt one side of the camera up, and remove the camera from the mount.

Video

The video is saved on the memory card as an .mp4 file. The G-Metrix™ sensor data is saved on the memory card as a .fit file.

Preparing to Record a Video

Before you start recording, you should set up your camera for the kind of footage you want to capture.

- 1 Select a lens mode to choose the size of the video and the lens or lenses to use ([Lens Modes, page 4](#)).
- 2 Select a video recording mode ([Video Modes, page 4](#)).
- 3 Attach the camera to a mount or tripod suitable for the kind of video you want to shoot ([Camera Mounts, page 3](#)).
- 4 Find a good shooting location and camera position ([Tips for Shooting 360-degree Video, page 4](#)).
- 5 Use the Garmin VIRB app to preview the camera view ([Remote Viewfinder, page 7](#)) and fine-tune the video settings ([Pro Settings, page 8](#)).
- 6 Start recording ([Recording a Video, page 4](#)).

Tips for Shooting 360-degree Video

Your VIRB 360 camera may be unlike cameras you have used before. Traditional cameras capture a fixed, rectangular field of view, which requires you to frame shots carefully and follow the subject to keep it in the frame. The VIRB 360 camera captures a full 360-degree sphere of video, recording everything around it, in every direction.

Shooting 360-degree video requires some considerations that may differ from traditional video recording.

- Put the VIRB 360 camera in the middle of the action.
A traditional forward-shooting camera is often placed with all the action in front of it. Because the VIRB 360 camera records in all directions, you should consider every angle and place the camera so that interesting video can be recorded in front, behind, above, and below the camera.
- Avoid blocking portions of the video sphere.
You may block a large portion of the recorded video sphere if you hold the camera closely in front of you or place it near a wall or other obstruction. You should place the camera where it has a clear view of the surroundings in all directions.
- Point the front lens toward the primary subject.
Although the camera records in all directions, the initial view for a 360-degree video centers on the front lens.
- Try placing the camera in a higher position to capture a broader, less-obstructed view.
A higher vantage point often provides a clearer, wider view. When recording action, you can hold the camera higher using the included tripod and grip, or you can mount the camera above you using an optional head mount or helmet mount. When recording an event, you can use a tripod to place the camera in a higher location that provides a line of sight above crowds and other visual obstructions.
- Check the lighting conditions in all directions.
When feasible, you should use the remote viewfinder in the Garmin VIRB app to verify the lighting conditions in all directions from the camera.

Recording a Video

NOTE: If the battery power becomes very low while recording video, the device automatically stops recording, saves the video, and safely turns off. The status LEDs flash rapidly when the battery charge level is low.

- 1 Move the recording switch forward to start recording video.
If the device is off, it turns on automatically. The device starts recording video immediately, and the red light turns on.
- 2 Move the recording switch backward to stop recording video.

Lens Modes

The lens mode determines which lens or lenses the camera uses while shooting video, and the size of the field of view.

Select ► > **Lens Mode**.

360: Records spherical 360-degree video using both lenses. The camera automatically stitches video from the two lenses into one 360-degree video file. The camera captures 360-degree video at 4K resolution. When you select 360 mode, you should select a stitching distance.

Front Only, Rear Only: Records rectangular 16:9 video using one lens. ▲ or ▼ points to the active lens. The camera captures 16:9 video at 1080p resolution.

RAW: Records separate 200-degree hemispherical video files from each lens, with a combined resolution of up to 5.7K. You can edit or share the video from each lens separately, or you can stitch both video files into a complete video sphere using video editing software.

Changing the Stitching Distance

Each camera lens captures 200 degrees horizontally and vertically, or slightly more than half of a sphere. When you are shooting 360-degree video, the camera joins, or "stitches," the two lens images at a set focal distance and removes the overlapping parts of the images. This creates a full sphere of video with little or no transition between the two lens images.

You can select the focal distance used for video stitching based on your shooting environment.

- 1 From the main menu, select **Setup > Stitch Distance**.
- 2 Select a stitching distance:
 - If you are shooting closer objects, indoors, or in closer surroundings, select **Near**.
This option sets a stitching distance of about 5 m (16 ft.) to optimize video stitching for most environments.
 - If you are shooting distant objects, outdoors, or in a large, open venue, select **Far**.
This sets a farther stitching distance to optimize video stitching for distant objects or landscapes.

Video Modes

Select ► > **Video Mode**.

Video: Captures full motion video using one or both lenses, based on the Lens Mode setting ([Lens Modes, page 4](#)).

Slow-Mo: Captures slow motion video. This mode is not available when you are using the 360 lens mode.

Time-lapse: Captures time-lapse video at a selected frame interval.

Recording a Time-Lapse Video

Time-lapse mode captures individual video frames at longer intervals and creates a video that plays much faster than real time. You can use time-lapse mode to record movements, changes, or events that take place slowly over a long period of time.

Time-lapse videos play at 30 frames per second. The length of the video depends on the amount of time between video frames. For example, if frames are recorded at a one-second interval, each second of video covers 30 seconds of real time. If frames are recorded at a 60-second interval, each second of video covers 30 minutes of real time.

- 1 From the main menu, select **Video Mode > Time-lapse**.
- 2 Select a time interval between video frames.

- For the best results, mount the device so it does not move while recording.
- Record a video.

Video Mode Specifications

| Lens Mode | Video Type | Resolution | Framerate |
|-------------------------|----------------|---|-----------|
| 360 | 360 stitched | 4K (3840 × 2160 px) | 30 fps |
| Front Only Rear Only | 16:9 | 1080p (1920 × 1080 px) | 60 fps |
| RAW | 360 unstitched | 5K (2 files at 2496 × 2496 px) 5.7K (2 files at 2880 × 2880) NOTE: 5.7K resolution mode requires the Garmin VIRB mobile app. (<i>Recording 5.7K RAW Video</i> , page 9) | 30 fps |

Slo-Mo Mode Specifications

| Lens Mode | Video Type | Resolution | Framerate |
|-------------------------|----------------|----------------------------------|---------------|
| 360 | Not available | Not available | Not available |
| Front Only Rear Only | 16:9 | 1080p (1920 × 1080 px) | 120 fps |
| RAW | 360 unstitched | 3.5K (2 files at 1760 × 1760 px) | 60 fps |

Time-Lapse Mode Specifications

| Lens Mode | Video Type | Resolution | Framerate |
|-------------------------|----------------|--------------------------------|-----------------------|
| 360 | 360 stitched | 4K (3840 × 2160 px) | User-defined interval |
| Front Only Rear Only | 16:9 | 1080p (1920 × 1080 px) | User-defined interval |
| RAW | 360 unstitched | 5K (2 files at 2496 × 2496 px) | User-defined interval |

Microphone Modes

You can change the microphone mode based on the recording environment.

From the main menu, select **Setup > Microphone**.

Spatial: Records spatial audio using all four microphones (*Planar Spatial Audio*, page 5). This option is not available when you are using the Front Only or Rear Only lens modes.

Rear Only: Records mono audio using only the rear microphone. This can help to reduce wind noise.

Off: Turns off all internal and external microphones, and records video without audio.

Planar Spatial Audio

While recording using both lenses, your camera can use all four camera microphones to record planar spatial audio. Planar spatial audio records location-specific sound from the 360-degree plane around you. It can precisely represent the location of a sound to the front, back, left, or right of the camera, or any place in between. While playing the video using a compatible player, the audio perspective follows the video perspective when you turn to view different parts of the video. Spatial audio is especially effective when viewing a video using a virtual reality headset.

The following technical specifications are provided for users performing advanced video and audio processing on the recorded file.

The camera uses Ambisonic B-format encoding to record spatial audio into four audio channels in the MP4 file.

| Channel | Encoded information |
|---------------|---|
| Channel 1 (W) | Audio from all directions. |
| Channel 2 (Y) | Information about audio to the left and right of the camera. |
| Channel 3 (Z) | Information about audio above or below the camera. ¹ |
| Channel 4 (X) | Information about audio to the front or back of the camera. |

Outputting Live Video to an External Device

You can use a micro HDMI® cable to output live video from the camera to an external device, such as a broadcasting or live-streaming device.

- Slide the latch ① to open the side door.

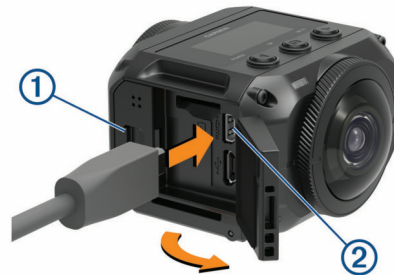

- Plug the cable into the **VIDEO** port ② on the camera.

NOTE: You cannot connect a power cable and a video cable at the same time. To provide external power while outputting video, you can use an optional powered mount accessory. Go to garmin.com/virb to purchase accessories.

- Plug the other end of the cable into your external device.

Photos

Taking Photos

Your camera can capture spherical 360-degree photos. You can change the photo mode to capture a single photo, a photo burst, or a series of time-lapse photos (*Photo Modes*, page 6).

- To take a photo, select

The camera takes a photo or photos in the active photo mode after the default self timer expires (*Setting the Default Photo Self Timer*, page 5).

- To increase the self-timer delay, hold until the correct delay time appears on the screen, and release .

The self-timer counts down, and the status LEDs flash yellow. The camera beeps to alert you when the self timer is close to expiring, and it beeps rapidly immediately before the camera takes a photo. After the self-timer expires, the camera takes a photo or photos in the active photo mode.

- While recording a video, select .

The camera marks the current video frame as a photo. You can use the VIRB Edit application to save the marked frame as a separate photo file (*VIRB Edit*, page 14). The camera cannot take a photo burst or time-lapse photos while recording video.

Setting the Default Photo Self Timer

You can change the default photo self timer from 0 to 60 seconds. The default self timer is used each time you press .

- From the main menu, select **Setup > Self Timer**.

¹ Because the VIRB 360 microphones are located on the front, back, and both sides of the device, channel 3 (Z) is intentionally left blank to meet the spatial metadata specifications of the video players. Sounds above and below the camera are captured in channel 1 (W), but only the sounds coming from the front, back, and sides are rendered with the full spatial audio effect during playback.

- 2 Select a time.

Photo Modes

You can change the photo mode to capture a single photo, a photo burst, or time-lapse photos. You can use either the camera or the Garmin VIRB app to change the photo mode (*Taking a Photo Using the Garmin VIRB App*, page 8). Some options are available only when using the Garmin VIRB app.

On the camera, select ► > **Photo Mode**.

Single

Single: Enables you to take a single photo using automatic exposure.

- Type sets the exposure type (*Photo Exposure Types*, page 9). This option is available only in the Garmin VIRB app.

Burst

Burst: Enables you to rapidly take multiple images over a set number of seconds. This mode is ideal for capturing photos of people or objects in motion.

- Burst Rate sets the speed at which the camera takes the sequence of photos.

Time-lapse

Time-lapse: Enables you to capture a series of photos at set time or distance intervals.

- Type sets the time-lapse video type. This option is available only in the Garmin VIRB app.
- Interval sets the time interval between photos.

Voice Control

The voice control feature allows you to control your camera using spoken commands.

Voice control is not available for all device languages. By default, the voice control language is the same as the software interface language, when available. You can set your preferred voice control language separately from the interface.

Setting Up Voice Control

- 1 From the main menu, select **Setup** > **Voice Control**.
- 2 Select **Status** to turn on the toggle switch.
- 3 Select **Language**, and select a language.
- 4 Select **Things to Try** to view a list of available voice control commands (optional).

You can control the camera by saying commands in the selected language.

Controlling the Camera Using Voice Commands

- 1 Say **OK, Garmin** to activate the voice control feature. The camera plays a tone to indicate the camera is listening for a command.
- 2 Say a command. When the camera recognizes your command, it plays a success tone. If the camera does not recognize your command, it plays an error tone.

Voice Control Commands

You can say any of these commands to control your VIRB 360 camera using your voice. You must activate the voice control feature by saying OK, Garmin before you say a command.

Start Recording: Starts recording video in the current video mode.

Stop Recording: Stops recording video.

Remember That: Places a bookmark in the video. This command allows you to mark key moments in the video as they occur so you can find them easily while editing the video. This command is available only while you are recording a video.

Take a Picture: Takes a single photo while not recording video, or places a bookmark in the video while recording video.

Enable Wi-Fi: Enables the Wi-Fi radio. This allows you to connect the camera to the Garmin VIRB app.

Disable Wi-Fi: Disables the Wi-Fi radio.

Voice Control Tips

- Speak in a normal voice directed at the device.
- Reduce background noise to increase the accuracy of the voice recognition.
- Before each command, say **OK, Garmin**.
- Listen for a tone to confirm that the camera successfully recognized a command.
- Watch the status LEDs to confirm the camera recognized the command.

The LEDs flash yellow twice to indicate the camera recognized the command. The LEDs flash red twice to indicate the command was not recognized.

G-Metrix

Using the built-in GPS receiver and sensors, your camera can detect G-force, altitude, speed, orientation, and many other performance metrics. This data is saved automatically as G-Metrix data. You can capture even more G-Metrix data by wirelessly connecting external ANT+ sensors, other Garmin devices, and compatible Bluetooth sensors, such as OBD-II sensors.

You can use the Garmin VIRB mobile app or the VIRB Edit desktop application to overlay G-Metrix data onto your video using gauges, graphs, and more. You can play and share your edited videos to show your speed, acceleration, heart rate, and other sensor data in real time.

G-Metrix Data

Your camera can record these types of G-Metrix data using the built-in sensors.

| | |
|--------------------------|-------------------|
| Speed | Rotations |
| G-force | RPM |
| Pace | Altitude |
| Distance | Bearing |
| Lap times | Orientation |
| Lap count | Elevation |
| Jump height | Grade |
| Hang time | Pitch |
| Jump distance | Roll |
| GPS location | Vertical speed |
| Track shape and position | Vertical distance |

Your camera can record these types of G-Metrix data using optional external sensors.

| G-Metrix Data | Required Sensor |
|-----------------------|--|
| Heart rate | Compatible ANT+ heart rate monitor |
| Cadence | Compatible ANT+ bicycle cadence sensor |
| Power output in watts | Compatible ANT+ power meter |
| Temperature | Compatible ANT+ temperature sensor |
| Automotive data | Compatible Bluetooth OBD-II sensor |

Garmin VIRB App

The Garmin VIRB app is an essential companion for your VIRB 360 camera that extends the camera's features and functions. The app connects to your camera using a Wi-Fi connection and provides remote access to basic and extended camera features.

- Remotely control video and photo recording.
- Preview your shot on a live 360-degree viewfinder.
- Fine tune the image with on-screen pro settings.
- Change the camera settings.
- View and share recorded videos and photos.
- Live stream video from your camera to the YouTube™ video community or the Facebook™ social network (Apple® devices only).

You can download the Garmin VIRB app free from the Apple App Store™ or from the Google Play™ Store. For more information about the Garmin VIRB app features and compatibility, go to garmin.com/virbapp.

Connecting to the Garmin VIRB App Using NFC

To connect to the Garmin VIRB app using near-field communication (NFC) technology, you must use a mobile device with Android™ that has NFC technology. If your mobile device is not compatible with this feature, you can connect to the app using the Wi-Fi settings ([Connecting to the Garmin VIRB App Using Wi-Fi Settings, page 7](#)).

The Garmin VIRB app connects to your VIRB 360 camera using Wi-Fi technology.

- 1 Turn on your VIRB 360 camera.
- 2 On your mobile device, verify the NFC feature is enabled.
The NFC feature is usually found in the wireless settings. For more information, see your mobile device owner's manual.
- 3 Touch the NFC area of your mobile device to the camera screen.
The NFC touch area is usually located on the back of the mobile device, near the middle. This location varies based on the device manufacturer and model. For more information, see your mobile device owner's manual.
After you touch the camera, the camera's Wi-Fi access point turns on, and the access point name and password appear on the camera screen.
- 4 From the app store on your mobile device, install and open the Garmin VIRB app.
The app automatically searches for your camera and displays a security prompt.
- 5 Touch the NFC area of your mobile device to the camera screen.
The app receives the access point password automatically.

The remote viewfinder and camera controls appear in the Garmin VIRB app.

In the future, you can touch your mobile device to the camera screen to automatically connect to the camera and open the Garmin VIRB app.

Connecting to the Garmin VIRB App Using Wi-Fi Settings

TIP: If you are using a mobile device with Android that has near field communication (NFC) technology, you can connect your camera more quickly using NFC ([Connecting to the Garmin VIRB App Using NFC, page 7](#)).

The Garmin VIRB app connects to your VIRB 360 camera using Wi-Fi technology. You can connect the app directly to the

camera, or you can connect the app and camera to the same wireless network.

- 1 From the app store on your mobile device, install the Garmin VIRB app.
- 2 On your VIRB 360 camera, from the main menu, select **Wireless > Wi-Fi**, and select the **Wi-Fi** toggle switch to turn on the Wi-Fi radio.

TIP: You can also hold ► for two seconds to quickly turn the Wi-Fi radio on or off.

The camera broadcasts a Wi-Fi access point. The access point name and password appear on the camera screen. While the Wi-Fi radio is turned on,  appears on the home screen, and the status LED flashes blue periodically.

- 3 If you are using an Apple mobile device, go to the Wi-Fi settings on your mobile device, and connect to the camera access point using the name and password on the camera screen.
- 4 On your mobile device, start the Garmin VIRB app.
The app searches for your camera.
- 5 If you are using a mobile device with Android, when the security prompt appears, enter the password for the camera access point.

TIP: The access point name and password appear on the camera screen.

The app connects to your camera.

The first time you connect your camera, the app prompts you to connect to a nearby wireless network.



- 6 Follow the on-screen instructions to connect the camera and app to a Wi-Fi network (optional).
You can also manually connect to a Wi-Fi network later ([Connecting to a Wi-Fi Network, page 11](#)).

The remote viewfinder and camera controls appear in the Garmin VIRB app.

Remote Viewfinder

The remote viewfinder appears in the Garmin VIRB app while the app is connected to your camera.



| | |
|---|---|
|  | Select to enable or change the pro settings (Pro Settings, page 8). |
| ① | Displays the sensor status, shooting mode, remaining memory card storage, and battery charge level. |
|  | Select to change the camera settings (App and Camera Settings, page 8). |
| ② | When you are using the 360 lens mode, swipe left, right, up, or down to view a different part of the 360-degree video sphere. Tap to show or hide menu icons. |
|  | Select to switch between multiple connected cameras (Switching Cameras, page 13). |
| ③ | Select to view or share recorded videos and photos (Garmin VIRB App Gallery, page 11). |

| | |
|---|---|
| ● | Select to start recording a video or to take a photo. |
| ④ | Select to change the video or photo shooting mode (<i>Recording a Video Using the Garmin VIRB App</i> , page 8). |

Pro Settings

From the viewfinder in the Garmin VIRB app, select .

TIP: While pro settings are enabled, you can swipe left from the viewfinder to quickly view or change the current pro settings.

: Enables or disables the pro settings. Disabling the pro settings sets the camera to full automatic mode. Your preferences are saved while the pro settings are disabled, and they are restored when you enable the pro settings again.

 **Exposure Bias:** Sets the exposure bias. Exposure bias affects the level of brightness.

 **ISO Limit:** Sets the maximum level of sensitivity and image noise. The camera automatically uses the best ISO level for the lighting conditions, up to this maximum. Higher ISO values have more visible noise or grain. Higher ISO values are best for use in low light environments or indoors. Lower ISO values are best for use in sunlight. You can use the 6400 option for brighter video in low light, the 1600 option for moderate brightness in low light, or the 400 option for darker video in low light.

 **Color Curve:** Sets the color palette. You can use the Vivid option for a more vibrant color palette, or the Flat option for a more neutral color palette.



 **Sharpness:** Sets the level of sharpness. You can use the High option for a sharper look, the Medium option for moderate sharpness, or the Low option for a softer look.

 **White Balance:** Adjusts the color tone based on your surroundings. The device can automatically adjust the white balance, or you can manually adjust the white balance. You can use the 2800K option for incandescent light, the 4000K option for fluorescent light, the 5000K option for daylight, the 6500K option for sunny conditions, or the 7500K option for cloudy conditions.

 **Exposure Lock:** Enables or disables exposure lock for videos. You can enable exposure lock to ensure consistent light sensitivity in your video capture. When recording a time-lapse video, this helps eliminate stray frames with slightly brighter or darker images.



 **Exposure Balance:** Sets which lens or lenses should be used to determine the exposure level. The camera can set independent exposure levels for each lens, or it can set a single exposure level based on the front lens, the rear lens, or both lenses. Independent exposure levels can improve the exposure of each lens when the lighting conditions for each lens are different. A single exposure level improves the stitching and blending of the two lens images and provides a more uniform, consistent appearance for the full video sphere.

Recording a Video Using the Garmin VIRB App

- From the viewfinder, select the shooting mode icon in the lower-right corner.
- Select .
- Select a video mode:
 - To record regular speed video, select **Video**.
 - To record slow-motion video, select **Slow-Mo**.
 - To record time-lapse video, select **Time-lapse**, and select a frame interval (*Recording a Time-Lapse Video*, page 4).
- Select  to start recording.
- When you are finished, select  to stop recording.

Taking a Photo Using the Garmin VIRB App

- From the viewfinder, select the shooting mode icon.

- Select , and select a photo mode (*Photo Modes*, page 6).
 - Select settings for the photo mode (optional).
 - Select the back button or touch anywhere on the viewfinder background to close the menu.
 - Select .
- The camera takes one or more photos based on the active photo mode.

Broadcasting Live Video

NOTICE

Live broadcasts may be visible to many viewers. Use caution when broadcasting live video.

It is your responsibility to follow all laws and restrictions for live broadcasts in your jurisdiction.

Live broadcasting requires the app to upload large amounts of data. Regular data limits and charges from your carrier or internet service provider apply. Contact your carrier or internet service provider for more information about data limits or charges.

To broadcast live video, your camera must be connected to an Apple device with the Garmin VIRB app and an active internet connection. Live broadcasting is not available for mobile devices with Android.

You can use the Garmin VIRB app to stream live video to social networks, including the Facebook social network and the YouTube video community. You can stream 360-degree videos or standard 16:9 single-lens videos.

- Connect your camera to the Garmin VIRB app.
- From the Garmin VIRB app, select the shooting mode icon in the lower-right corner, and select **Broadcast Live**.
- Select an option:
 - To stream to the YouTube video community, select **YouTube**, select **Sign in with Google**, and follow the on-screen instructions to sign in to your Google™ account.
 - To stream to the Facebook social network, select **Facebook**, select **Sign in to Facebook**, and follow the on-screen instructions to sign in to your Facebook account.
- Select one or more options to edit the broadcast details:
 - To change the title of the broadcast, select **Title**.
 - To enter a description of the broadcast, select **Description**.
 - To change the resolution of the broadcast, select **Resolution**.

NOTE: Higher resolutions require a higher-speed internet connection and consume a larger amount of data.
 - To change the privacy setting for the broadcast, select **Privacy**.

NOTICE

The broadcast privacy options are provided and implemented by the selected third-party social network. Video or data broadcast to the internet may be visible to third parties. Garmin is not responsible for the privacy of your video or data.

- To sign out of your account or sign in to a different account, select **Sign Out**.
- Select the viewfinder image to close the menu.
 - Select **GO LIVE** to start broadcasting.

App and Camera Settings

You can use the Garmin VIRB app to change video, photo, and system settings on your connected VIRB camera. You can also

change settings and view software information for the Garmin VIRB app.

From the viewfinder, select .

Friendly Name: Sets the name that identifies your camera to other Bluetooth devices.

Lens Mode: Sets the lens mode for the connected camera ([Lens Modes, page 4](#)).

Live Preview Audio: Plays the live audio received by the camera microphone on your mobile device speakers.

Network Name and Password: Sets the network name (SSID) and password for the camera access point.

Wi-Fi Connections: Allows you to connect the camera to a Wi-Fi access point, view saved Wi-Fi networks, and forget saved Wi-Fi networks.

Check for Updates: Allows you to download and install software updates for the connected camera.

Locate Camera: Plays a repeating tone from the connected camera. This is useful to identify a specific camera when multiple cameras are connected. It can also help you to locate a nearby, misplaced camera.

Video Mode: Sets the video mode ([Video Modes, page 4](#)).

Resolution: Sets the video resolution when using RAW lens mode.

Type: Sets the time-lapse interval type ([Recording a Time-Lapse or Travelapse Video, page 10](#)).

Interval: Sets the time interval between video frames for time-lapse mode, or the distance interval between video frames for Travelapse™ mode.

Loop: Allows you to record a video loop and sets the duration of the loop recording ([Recording a Video Loop, page 9](#)).

Video Lens Correction: Enables the camera to correct distortion, such as unwanted curvature or magnification, at the edges of the video. This option is available only for 16:9 single-lens modes.

Photo Mode: Sets the photo mode ([Photo Modes, page 6](#)).

Self Timer: Sets the photo self timer from 0 to 60 seconds.

Photo Lens Correction: Enables the camera to correct distortion, such as unwanted curvature or magnification, at the edges of the photo. This option is available only for 16:9 single-lens modes.

Burst Rate: Sets the speed at which the camera takes the sequence of photos in burst mode.

Type: Sets the photo exposure type ([Photo Exposure Types, page 9](#)).

Exposure Time: Sets the exposure time when taking photos or time-lapse photos at night.

ISO Limit: Sets the maximum level of sensitivity and image noise for night photos. The camera automatically uses the best ISO level for the lighting conditions, up to this maximum. Higher ISO values provide a brighter image in low light environments but show more visible noise or grain.

Interval: Sets the time interval between photos for time-lapse mode, or the distance interval between photos for Travelapse mode.

Duration Mode: Sets the duration for extended time-lapse mode. You can shoot continuously, or set a custom duration.

Start Time Mode: Sets the start time for extended time-lapse mode. You can start shooting now, or set a custom start time.

GPS: Enables the camera to determine your location, speed, and elevation using GPS satellite signals. When this setting is enabled, the camera includes GPS information in the G-Metrix data when you record a video or photo.

NOTE: Your camera records GPS position data at all times when the GPS setting is enabled. This data is not collected by Garmin.

Recording Light: Turns the recording LED on or off. This can be useful to eliminate ambient light from the LED when recording in darker environments.

Tones: Turns the camera tones on or off. When this setting is enabled, tones play to indicate various camera actions and statuses, such as capturing a photo, starting recording, or connecting to a device.

Auto-Off: Allows the camera to enter low-power mode after it has not been used for a selected amount of time.

Microphone: Allows you to change the microphone mode or turn the microphones off ([Microphone Modes, page 5](#)).

Format: Allows you to set the regional video format to NTSC or PAL. The video format affects the available video frame rate (FPS) options for some video modes.

Units: Sets the units of measure used to display G-Metrix data in the Garmin VIRB app.

About: Displays information about the Garmin VIRB app, including the version, license information, and the privacy agreement.

Clear Temporary App Data: Deletes some temporary data generated by the app to improve app performance, such as photo or video thumbnails. Clearing temporary app data does not clear all user data from the app.

Photo Exposure Types

You can use several photo exposure types to take single photos.

Standard: Takes a single photo at standard exposure. This option is useful for most daytime photos.

Night: Takes a single, extended-exposure photo. This option is useful for capturing photos in low light conditions.

Bracket: Takes three consecutive photos automatically, using three different exposure values (exposure bracketing). This option is useful for manually composing high dynamic range (HDR) photos.

HDR: Captures an HDR photo, which uses multiple exposure levels to capture more detail in bright or dark areas of the image.

Recording 5.7K RAW Video

Using the Garmin VIRB app, you can set the camera to record high-bitrate RAW video at 5.7K resolution. This mode allows you to capture the highest level of detail in all directions.

When recording in RAW mode, the camera records separate hemispherical video files from each lens. You can stitch these files into a spherical video using video editing software.

NOTE: 5.7K mode is a highly demanding mode that causes your camera to work harder. The camera's battery run time, memory card recording time, and ability to operate in hot environments are reduced. The camera protects itself from overheating and shuts down automatically if the internal temperature exceeds the operating temperature threshold.

- 1 Connect the camera to the Garmin VIRB app.
- 2 From the app viewfinder, select  > **Lens Mode** > **RAW**.
- 3 Scroll to the **Video Settings** section, and select **Resolution** > **5.7K**.

Recording a Video Loop

You can use the Garmin VIRB app to set your camera to record a video loop. Loop recording allows you to record video continuously but save only the most recent video footage. You can select the number of minutes of video to save. This enables you to save storage space when you want to capture key moments but do not want to save all footage of an activity. This

feature is useful when using the device as a driving recorder or when you want to save only the highlights of an event.

- 1 Connect your camera to the Garmin VIRB app.
- 2 From the app viewfinder, select **⚙️ > Loop**.
- 3 Select the number of minutes of video to save.
- 4 Start recording video.

The most recent footage is saved on the memory card, up to the number of minutes selected in step 2.

Time-Lapse Photos and Video

You can use several time-lapse modes to take a series of photos or video frames at a set interval.

Standard: Standard time-lapse mode takes a series of photos or video frames at a set time interval. This mode is useful for most daytime time-lapse photos or videos, and for when you want to start and stop time-lapse recording manually.

Extended: Extended time-lapse mode takes series of photos at a longer time interval, with an optional automatic start time and duration. While using extended time-lapse mode, the camera goes into low power mode between shots to extend the battery life. This mode is useful when you want to capture time-lapse photos over an extended time period, or when you cannot attend the camera to start and stop time-lapse recording manually.

NOTE: This mode is available for photos only.

Night: Night time-lapse mode takes a series of extended-exposure photos at a set time interval. This mode is useful for capturing time-lapse photos in low light conditions, or for capturing a series of extended-exposure photos at a fixed location.

NOTE: This mode is available for photos only.

Travelapse: Travelapse mode takes a series of photos or video frames at a set distance interval, in kilometers or miles. This mode is useful for capturing a series of photos during a long road trip.

Recording a Time-Lapse or Travelapse Video

You can use the Garmin VIRB app to set up the time-lapse recording mode for your camera. Time-lapse mode captures individual video frames at longer intervals and creates a video that plays much faster than real time. You can record a standard time-lapse video or a Travelapse video.

Standard time-lapse mode captures individual video frames at set time intervals, and it is useful for recording movements, changes, or events that take place slowly over a long period of time. Travelapse mode captures video frames at a set distance interval. For example, you can capture one video frame for every kilometer or mile you travel on a road trip. This allows you to record and share a short video of your whole road trip and the places you traveled.

- 1 Use an appropriate tripod or mounting accessory to mount the camera in a fixed position.
- 2 Connect your camera to the Garmin VIRB app.
- 3 From the app viewfinder, select **⚙️ > Video Mode > Time-lapse**.
- 4 Select **Type**, and select an option.
 - To record standard time-lapse videos, select **Standard**.
 - To record your travels at a distance interval, select **Travelapse**.
- 5 Select **Interval**, and select the time or distance interval between video frames.
- 6 Start recording a video.

The camera records video frames at the selected interval.

Taking Time-Lapse Photos Using the Garmin VIRB App

- 1 Connect your camera to the Garmin VIRB app.

- 2 From the app viewfinder, select **⚙️ > Photo Mode > Time-lapse**.
- 3 Select **Type > Standard**.
- 4 Select **Interval**, and select a time interval between photos.
- 5 On the camera, select **📷**.

The camera takes a series of photos at the selected interval. The screen displays the elapsed time, and the LEDs flash red each time the camera captures a photo.

- 6 Select **📷** again to stop taking photos.

Taking Extended Time-Lapse Photos

- 1 Connect your camera to the Garmin VIRB app.
- 2 From the app viewfinder, select **⚙️ > Photo Mode > Time-lapse**.
- 3 Select **Type > Extended**.
- 4 Select **Start Time Mode**, and select the time of day when the camera should start taking time-lapse photos.

If you select **Now**, the camera starts taking pictures immediately after you select the photo key.
- 5 Select **Interval**, and select a time interval between photos.
- 6 Select **Duration Mode**, and select the amount of time for which the camera should continue taking photos.

If you select **Continuous**, the camera continues taking photos until you stop it manually.
- 7 Aim the camera at the subject of the time-lapse photos.
- 8 On the camera, select **📷**.

At the start time, the device takes a series of photos at the selected interval. The camera stops taking photos automatically after the selected duration has elapsed.

NOTE: The camera appears to be off while taking extended time-lapse photos. To preserve power, the screen, LED, and other features are disabled, but the camera continues to take photos.

- 9 To manually stop taking photos, hold **POWER** to turn on the camera, and select **📷**.

Taking Time-Lapse Photos at Night

When taking time-lapse photos at night, you should attach the camera to a stable mount and allow time to test your photo settings.

- 1 Connect your camera to the Garmin VIRB app.
- 2 From the app viewfinder, select **⚙️ > Photo Mode > Time-lapse**.
- 3 Select **Type > Night**.
- 4 Select **Interval**, and select a time interval between photos.
- 5 Select **Exposure Time**, and select an exposure time for each photo.

You should select a longer exposure time for darker lighting conditions, or if you want to capture motion blur in your image.
- 6 Select **ISO Limit**, and select an option appropriate for the lighting conditions.
- 7 Attach the camera to a stable mount, or set the camera on a stable surface.

Preventing the camera from moving helps to reduce blurring in photos with longer exposure times.
- 8 On the camera, select **📷**.

The camera takes a series of photos at the selected interval.
- 9 Check the first several photos to verify the photo settings are correct for the lighting conditions (optional).
- 10 Select **📷** again to stop taking photos.

Garmin VIRB App Gallery

You can use the Garmin VIRB app to view, edit, and share videos and photos stored on your camera.

With your camera connected to the app, from the viewfinder, select the thumbnail image in the lower left corner.

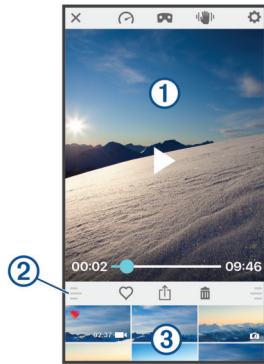

| | |
|--|--|
| | Select to change the G-Matrix gauge overlays for the selected video. |
| | Select to change the viewing mode for 360-degree video. You can view 360-degree videos on the screen or in a virtual reality (VR) headset. |
| | Select to apply image stabilization to the selected video. |
| | Select to change the camera settings. |
| | Displays a preview of the selected photo or video. |
| | Drag up or down to expand or shrink the library. |
| | Select to mark the selected video or photo as favorite. |
| | Select to edit, save, and share the selected photo or video. |
| | Select to delete the selected video or photo. |
| | Select a photo or video thumbnail to preview it. |

Viewing a Photo or Video

- From the Garmin VIRB app viewfinder, select the thumbnail image in the lower-left corner.
- From the library in the lower half of the gallery, select a video or photo thumbnail.

A preview of the item appears.

NOTE: The app cannot play or preview videos recorded in RAW mode. You can use the VIRB Edit desktop application to view and edit RAW videos.

- Select an option:
 - Touch anywhere on the preview image to view the video or photo on the full screen.
 - Rotate your mobile device to view the item in portrait or landscape mode.
 - If you are viewing 360-degree spherical content, drag the image to view different parts of the video or photo sphere.
 - If you are viewing a video, select ▶ to start playback.

Using Virtual Reality (VR) Viewing Mode

You can view 360-degree spherical videos in virtual reality (VR) mode. VR mode allows you to move your phone around you to view different parts of the video sphere. This allows you to experience your video differently and discover new details each time you watch it. If the video was recorded with spatial audio, the audio perspective changes as you change your view of the video sphere.

For an even more immersive experience, you can view the video in a VR headset compatible with the Google Cardboard™ VR platform, and you can also use headphones to experience the full effect of the spatial audio.

- From the Garmin VIRB app gallery, select a 360-degree video.
- Select .
- Select an option:
 - To view the video using a VR headset, select **Cardboard VR**, and place your device into the VR headset. This option requires a headset compatible with the Google Cardboard VR platform.
 - To view the video using only your phone screen, select **360°**.
- Select ▶ to start playback.
- Move your phone around you or look around with your headset to view different parts of the video sphere.

Your phone screen or headset acts as a virtual window into the video sphere. As you move it, you can look up, down, in front of, beside, or behind yourself.

Editing and Sharing a Video

- From the Garmin VIRB app gallery, select a video.
- Select an option:
 - If you are using an Apple device, select .
 - If you are using a device with Android, select .

The editing page appears. Tabs along the bottom of the page allow you to edit different video features.
- Select an option:
 - To edit the video orientation and image stabilization, select .
 - To trim the video, select .
 - To change the playback speed, select .
 - To change the recorded audio volume or to add a musical soundtrack, select .
 - To edit the G-Matrix overlays, select .
- When you are finished editing the video, select **Next**.
The app processes the video. This may take a while depending on the length of the video.
TIP: By default, the app process the video using a mobile device quality profile. To save or share a full quality video, you can select Switch to Highest Quality.
- After the app finishes processing the video, select an option:
 - To save the video to your mobile device, select .
 - To share the video to a social network using an Apple device, select .
 - To share the video to a social network using a device with Android, select .

Connecting to a Wi-Fi Network

NOTICE

Connecting to a public or unsecured network may expose your video and sensor data to others. Use caution when connecting to an unsecured network.

To control the camera using an existing Wi-Fi network, the network must be set up to allow connected devices to see and communicate with each other.

You can use the Garmin VIRB app to connect your VIRB camera to a Wi-Fi network. This could be a home network or a business network.

While connected to a Wi-Fi network, the Garmin VIRB app communicates with your camera over the network. If the network provides access to the internet, this feature allows your mobile device maintain an internet connection while you control your camera using the Garmin VIRB app.

TIP: If your wireless router or access point supports Wi-Fi Protected Setup (WPS), you can quickly connect your camera directly to the Wi-Fi network without using the Garmin VIRB app (*Connecting Directly to a Wi-Fi Network Using WPS*, page 15).

- 1 Connect your camera to the Garmin VIRB app (*Connecting to the Garmin VIRB App Using Wi-Fi Settings*, page 7).
- 2 From the Garmin VIRB app viewfinder, select **⚙ > Wi-Fi Connections**.

A list of nearby Wi-Fi access points appears.

- 3 Select your Wi-Fi network, and enter the network password.

The app and the camera connect to the Wi-Fi network.

The app and camera save the network information and connect automatically the next time the camera is turned on and within range of the network. Saved networks appear in the Wi-Fi menu on your camera.

If you have additional VIRB cameras, you can add them to the network to control multiple cameras using the Garmin VIRB app (*Adding a Camera to the Network*, page 12).

Turning the Wi-Fi Radio On or Off

From the main menu, select **Wireless > Wi-Fi**, and select the **Wi-Fi** toggle switch.

TIP: You can also hold **▶** for two seconds to quickly turn the Wi-Fi radio on or off.

While the Wi-Fi radio is turned on,  appears on the home screen, and the status LED flashes blue periodically.

Changing the Wi-Fi Connection

After you have connected to a Wi-Fi network, saved networks appear in the Wi-Fi menu on your camera. You can manually change the Wi-Fi connection to connect to a saved network, or to force the camera to broadcast its own access point.

- 1 From the main menu, select **Wireless > Wi-Fi**.
- 2 Select **◀** or **▶** to scroll through the list of Wi-Fi connections.
- 3 Select an option:
 - To enable the camera access point and disconnect from other networks, select the access point.
 appears next to the access point name.
 - To disable the camera access point and connect to a wireless network, select the saved network.

Forgetting a Wi-Fi Network

You can use the Garmin VIRB app to forget a saved network and remove it from your camera.

- 1 With your camera connected to the Garmin VIRB app, from the app viewfinder, select **⚙ > Wi-Fi Connections**.
Saved networks appear at the top of the list, below the Auto-Connect To heading.
- 2 Select **Forget** next to the network you want to remove from your camera.

After you forget a network, the camera no longer connects to it automatically.

Multiple Camera Network

You can create a network of multiple VIRB cameras and control all the cameras using the Garmin VIRB app. You can switch between the connected cameras to view the viewfinder and controls for each camera.

To connect multiple cameras, all the cameras and your mobile device must be connected to the same wireless access point or network.

You can set up the network using the access point feature of one VIRB camera. The app and all your cameras connect to this access point.

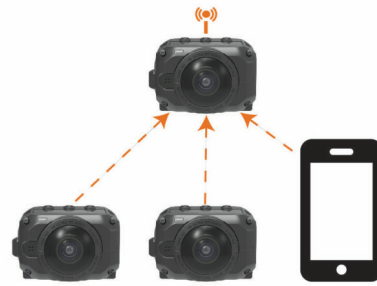

You can also set up a camera network using an existing Wi-Fi network. The app and all cameras connect to the Wi-Fi network. This option is useful when you want to provide internet access to your mobile device while controlling your cameras.



Setting Up a Camera Network

You can set up a multiple-camera network using the access point feature of one VIRB camera. This allows the VIRB app to control all your cameras through this access point.

The first time you use multiple cameras with the Garmin VIRB app, you must set up the camera access point and connect another camera to it.

- 1 Turn on the first camera, and turn on the Wi-Fi radio (*Turning the Wi-Fi Radio On or Off*, page 12).
The camera broadcasts a Wi-Fi access point. You should not connect this camera to the app yet.
- 2 Turn on the second camera, and connect it to the app (*Connecting to the Garmin VIRB App Using Wi-Fi Settings*, page 7).

The camera connects to the app, and the viewfinder appears.

- 3 From the Garmin VIRB app viewfinder, select **⚙ > Wi-Fi Connections**.
A list of nearby Wi-Fi access points appears.
- 4 Select the access point broadcast by the first camera, and enter the password.

TIP: The access point name and password appear on the first camera's screen.

The app and the second camera connect to the access point. The app communicates with both cameras through the access point. You can select  in the viewfinder to switch between your connected cameras (*Switching Cameras*, page 13).

The app and cameras save the Wi-Fi network information. The next time you turn on your cameras, you should turn on the access point camera first, followed by the other cameras. The cameras connect automatically.

If you have additional VIRB cameras, you can add them to the camera network (*Adding a Camera to the Network*, page 12).

Adding a Camera to the Network

Before you can add a camera to a camera network, you must complete one of these tasks:

- Set up a camera network using a VIRB camera access point ([Setting Up a Camera Network, page 12](#)).
- Connect one or more cameras and the Garmin VIRB app to a Wi-Fi network ([Connecting to a Wi-Fi Network, page 11](#)).

If the Garmin VIRB app is connected to your cameras using a network or access point, you can add cameras to the camera network.

- 1 With the camera network turned on, turn on the new camera.
- 2 On the new camera, turn on the Wi-Fi radio ([Turning the Wi-Fi Radio On or Off, page 12](#)).

The new camera broadcasts a Wi-Fi access point.

- 3 On your mobile device, go to the Wi-Fi settings, and connect to the access point broadcast by the new camera.

TIP: The access point name and password appear on the new camera's screen.

For more information about connecting your mobile device to a Wi-Fi network, see your mobile device owner's manual.

- 4 On your mobile device, start the Garmin VIRB app.

The viewfinder for the new camera appears.

- 5 Select  > **Wi-Fi Connections**.

A list of nearby Wi-Fi access points appears.

- 6 Select the Wi-Fi access point or network used by your existing camera network, and enter the network password.

This could be a VIRB camera access point or a Wi-Fi network.

The app and the new camera connect to the network. You can select  in the viewfinder to switch between your connected cameras, including the new camera ([Switching Cameras, page 13](#)).

Switching Cameras

When multiple cameras are connected to the Garmin VIRB app, you can switch between the cameras to control each camera. While a connected camera is active, you can access the viewfinder, camera controls, and settings for that camera.

- 1 From the viewfinder, select .

- 2 Select a camera name.

The viewfinder for the selected camera appears.

Remote Control

You can remotely start recording, stop recording, and take pictures on your VIRB camera using the VIRB Remote accessory or a compatible Garmin device with the VIRB remote feature, such as a watch, activity tracker, or navigation device. You can also use one VIRB camera to control one or more other VIRB cameras. For more information about VIRB remote compatibility, see the owner's manual for your Garmin device.

The VIRB Remote accessory is a portable, mountable remote that can control your VIRB camera using ANT+ wireless technology. It has tactile buttons that allow you to start recording, stop recording, or take a photo without looking at the remote. Go to garmin.com/virb to purchase a VIRB Remote accessory.

Controlling Your VIRB Camera Remotely

These instructions allow you to enable the remote control feature for one camera or for your main camera. If you have multiple cameras, you should follow the instructions for controlling multiple cameras remotely ([Controlling Multiple VIRB Cameras, page 13](#)).

- 1 On your camera, from the main menu, select **Wireless > Remote**, and select the toggle switch to turn on the remote control feature.

The camera searches for a nearby main VIRB camera.

- 2 After the search times out, select **X**.

The remote control settings appear, with this camera set as the main VIRB camera.

- 3 Select an option:

- On your compatible Garmin device, launch the VIRB app or feature. See the owner's manual for the device for more information.
- On the VIRB remote, follow the pairing instructions in the accessory manual.

Controlling Multiple VIRB Cameras

You can use one VIRB camera to control one or more other VIRB cameras. This allows you to perform the same action using multiple cameras at the same time.

To control multiple cameras, you must choose a main camera. This camera controls the other cameras, which are called extended cameras. When you start recording or take a photo on the main camera, the extended cameras start recording or take a photo at the same time. When you send a remote command using a VIRB remote or a compatible Garmin device, the main camera receives the remote command and sends it to the extended cameras.

- 1 Bring all of your VIRB cameras within 3 m (10 ft.) of each other.

- 2 On your main VIRB camera, from the main menu, select **Wireless > Remote**, and select the toggle switch to turn on the remote control feature.

The camera searches for a nearby main VIRB camera.

- 3 After the search times out, select **X**.

The remote control settings appear, with this camera set as the main VIRB camera.

- 4 Exit the menu and return to the home screen.

- 5 On your extended VIRB camera, select **Wireless > Remote**, and select the toggle switch to turn on the remote control feature.

The camera searches for your main VIRB camera and connects to it automatically as an extended camera.

TIP: If your camera is set to the incorrect mode, you can select **VIRB Type** to switch between the Main VIRB and Extended VIRB modes.

- 6 Repeat step 5 for each extended camera.

- 7 After all of the cameras are connected, select an option:

- To start and stop recording on all of your cameras, use the recording switch on your main camera.
- To take a photo from all of your cameras, select the photo key on your main camera.
- To control all of your cameras remotely, pair a VIRB remote or compatible Garmin device with your main camera ([Controlling Your VIRB Camera Remotely, page 13](#)).

Enabling the Remote Wake Up Feature

The Wake On feature enables your camera to remain in a low-power state instead of turning off. This allows your remote control device to wake the camera to start recording or take a photo.

NOTE: This feature consumes some battery power when the camera is off. To avoid draining the battery, you should disable this feature when you are not using the camera, or when you store the camera overnight or for a longer time period.

Select **Wireless > Remote > Wake On**.

When you turn off the camera, it enters remote wake-up mode.

ANT+ Sensors

Your device can be used with wireless ANT+ sensors. For more information about compatibility and purchasing optional sensors, go to <http://buy.garmin.com>.

Pairing ANT+ Sensors

When you pair a compatible ANT+ sensor with your device, the sensor data is recorded as G-Metrix data.

- 1 Put on the heart rate monitor, and install and activate the sensor.
- 2 Bring the camera within 3 m (10 ft.) of the sensor.
- 3 From the main menu, select **Wireless > Sensors > Add New**.
The camera detects your sensor, and the sensor name appears on the screen.
- 4 Select the sensor name, and select ✓.
After the sensor is paired with your device, the sensor status changes to Connected.

After you pair the first time, your camera automatically recognizes and connects to the ANT+ accessory each time it is activated and within range.

Removing Paired ANT+ Sensors

- 1 From the main menu, select **Wireless > Sensors**.
- 2 Select a sensor.
- 3 Select **Forget Device > ✓**.

Bluetooth Devices

Connecting a Wireless External Microphone

You can connect a Bluetooth hands-free device with your VIRB camera.

- 1 From the main menu, select **Wireless > Bluetooth > Status** to turn on Bluetooth wireless technology.
- 2 Select **Add New**.
- 3 Select the wireless device to pair.
After the wireless device is paired, the device status changes to Connected.

Connecting an OBD-II Device

Your VIRB camera can pair with a compatible Bluetooth ELM327 on-board diagnostics (OBD-II) device to record automotive data from your OBD-II compliant vehicle.

NOTE: Different vehicles provide different data. Not all vehicles and OBD-II devices are compatible with the camera.

- 1 Install your ELM327 compatible OBD-II device in the OBD-II port of your vehicle.
TIP: See the owner's manual for your vehicle and your OBD-II device for information about locating the OBD-II port and installing the OBD-II device.
- 2 If necessary, enable pairing mode on your OBD-II device.
TIP: See the owner's manual for your OBD-II device to enable pairing mode.
- 3 From the VIRB camera main menu, select **Wireless > Bluetooth > Status** to turn on Bluetooth wireless technology.
- 4 Select **Add New**.
- 5 Select the OBD-II device to pair.
TIP: If your OBD-II device does not appear in the list, confirm that it is still in pairing mode and search again.
After the OBD-II device is paired, the device status changes to Connected.

Removing Paired Bluetooth Devices

- 1 From the main menu, select **Wireless > Bluetooth**.
- 2 Select a wireless device.
- 3 Select **Forget > ✓**.

VIRB Edit

The VIRB Edit application provides easy access to these tools and services for your device.

- Review and edit recorded videos
- Apply image stabilization to recorded videos
- Add G-Metrix gauges, graphs, and more
- Add titles and transitions
- Edit videos from multiple cameras
- Update software and features
- Additional editing, sharing, and playback features

The VIRB Edit application is available for Windows® and Mac® computers. Go to garmin.com/VIRBEdit for more information.

Customizing the Device

Setup Menu

NOTICE

Select ► > **Setup**.

Stitch Distance: Sets the focal distance used to stitch 360-degree video (*Changing the Stitching Distance, page 4*).

Voice Control: Allows you to control your camera using spoken commands (*Voice Control, page 6*).

Record Light: Turns the recording LED on or off. This can be useful to eliminate ambient light from the LED when recording in darker environments.

Tones: Turns the camera tones on or off. When this setting is enabled, tones play to indicate various camera actions and statuses, such as capturing a photo, starting recording, or connecting to a device.

Self Timer: Sets the length of the default self timer used when you take a photo.

Microphone: Allows you to change the microphone mode or turn the microphones off (*Microphone Modes, page 5*).

System: Allows you to change system settings, such as language, units, region, and GPS.

SD Card: Allows you to view detailed information about the installed memory card or format the memory card.

About: Displays important software information, your unit ID, and regulatory and compliance information.

Formatting Your Memory Card

NOTICE

Erased data cannot be restored.

You can format the memory card installed in your camera to erase all photos, videos, and other data. You may also need to format the memory card the first time you use it in your camera.

From the main menu, select **Setup > SD Card > Format Card > ✓**.

System Settings

From the main menu, select **Setup > System**.

GPS: Enables the camera to determine your location, speed, and elevation using GPS satellite signals. When this setting

is enabled, the camera includes GPS information in the G-Matrix data when you record a video or photo.

NOTE: Your camera records GPS position data at all times when the GPS setting is enabled. This data is not collected by Garmin.

Language: Sets the on-screen text language.

Units: Sets the system for units of measure to metric or statute.

Auto-Off: Turns off the camera automatically after it has not been used for five minutes.

External Power: Sets the camera behavior when it is connected to external power. You can select the Charge Mode option to enter charging mode automatically or the Power On option to turn the camera on. While in charging mode, the screen and all other features turn off (*Charging the Battery*, page 1).

Factory Reset: Restores all settings to the factory default values.

Device Information

Status LEDs

The LEDs on the front of the camera indicate the camera status.

| LED Color | LED Action | Status |
|----------------|--|--|
| Green | Flashing | The camera is turned on, but it is not recording. |
| Green | Solid | The camera is connected to a computer in USB mass storage mode. |
| Off | Off (while not connected to external power) | The camera is turned off. |
| Off | Off (while connected to external power) | The camera is turned off, and the battery is fully charged. |
| Red | Solid (top LED only) | The battery is charging. |
| Red | Flashing | The camera is recording video. |
| Yellow and red | One or more yellow flashes, followed by a long red flash | The camera has captured one or more photos. The LED flashes yellow while the self-timer is counting down and red when the photo is captured. |
| Green or red | Flashing rapidly | The camera will turn off or stop recording soon. This could be because the battery is below a 10% charge level, the memory card has less than 10 minutes of recording time remaining, or the internal temperature is too high. |
| Blue | Flashing intermittently | The Wi-Fi radio is turned on. |

Connecting Directly to a Wi-Fi Network Using WPS

NOTICE

Connecting to a public or unsecured network may expose your video and sensor data to others. Use caution when connecting to an unsecured network.

To control the camera using an existing Wi-Fi network, the network must be set up to allow connected devices to see and communicate with each other.

If your wireless router or access point supports Wi-Fi Protected Setup (WPS), you can quickly connect your camera directly to the Wi-Fi network without using the Garmin VIRB app.

- 1 Bring the camera near your wireless router or access point.
- 2 From the camera's main menu, select **Wireless > Wi-Fi**.

- 3 If necessary, select the **Wi-Fi** toggle switch to turn on the Wi-Fi radio.

While the Wi-Fi radio is turned on, additional options appear in the Wi-Fi menu.

- 4 Press **▶** to select **WPS**, and press **OK**.

The camera begins searching for a WPS-enabled Wi-Fi network.

- 5 Within two minutes, enable the WPS feature on your wireless router or access point.

On most dedicated wireless routers, the WPS feature is enabled by pressing a physical button. This button may be labeled with "WPS" or the WPS logo. If your access point is integrated in another type of wireless device, the WPS feature may be enabled in the device settings or an on-screen menu. See the owner's manual for your wireless router or access point for more information.

The camera connects to the Wi-Fi network.

The camera saves the network information and connects automatically the next time it is turned on and within range of the network. Saved networks appear in the menu on your camera.

Garmin Support Center

Go to support.garmin.com for help and information, such as product manuals, frequently asked questions, videos, and customer support.

Software Updates

For the best experience, you should keep the software on your camera up to date. Software updates provide changes and improvements to the device features and operation. You can use any of these applications to update the camera software.

- Garmin VIRB mobile app
- VIRB Edit desktop application
- Garmin Express™ desktop application

Updating the Camera Software Using the Garmin VIRB App

NOTE: To update the camera software, you must have a microSD card installed in the camera.

You can update the camera software using the Garmin VIRB mobile app. After you pair the app with your camera, the app checks for updates automatically and displays a message when an update is available.

- 1 From the Garmin VIRB app, when an update is available, select **Download**.
- 2 Follow the on-screen instructions to complete the update process.

Updating the Software with Garmin Express

NOTE: To update the camera software, you must have a microSD card installed in the camera.

You can use the Garmin Express application to download and install the latest software updates for your camera.

- 1 If you do not have the Garmin Express application installed on your computer, go to garmin.com/express and follow the on-screen instructions to install it (*Installing Garmin Express*, page 16).
- 2 Slide the latch ① to open the side door.

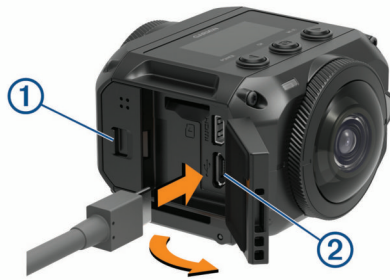

3 Connect your device to your computer using a micro-USB cable.

The small end of the cable connects to the micro-USB port ② on your camera, and the large end connects to an available USB port on your computer.

4 Hold **POWER** to turn on the camera.

☛ appears on the camera screen to indicate the camera is connected to your computer.

5 Open the Garmin Express application.

6 In the Garmin Express application, click **Add a Device**.

The Garmin Express application searches for your device and displays the device name and serial number.

7 Click **Add Device**, and follow the on-screen instructions to add your device to the Garmin Express application.

When setup is complete, the Garmin Express application displays the updates available for your device.

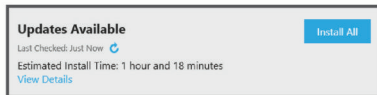

8 Select an option:

- To install all available updates, click **Install All**.
- To install a specific update, click **View Details**, and click **Install** next to the update you want.

The Garmin Express application downloads and installs the updates onto your device.

9 Follow the on-screen instructions during the update process to finish installing updates.

For example, during the update process, the Garmin Express application may instruct you to disconnect and reconnect your device.

Installing Garmin Express

The Garmin Express application is available for Windows and Mac computers.

1 On your computer, go to garmin.com/express.

2 Select an option:

- To view the system requirements and verify the Garmin Express application is compatible with your computer, select **System Requirements**.
- To install on a Windows computer, select **Download for Windows**.
- To install on a Mac computer, select **Download for Mac**.

3 Open the downloaded file, and follow the on-screen instructions to complete the installation.

Specifications

| | |
|---|---------------------------------------|
| Water rating | 1 ATM ¹ |
| Operating temperature range (external power) ² | From -20 to 40° C (from -4 to 104° F) |

¹ The device withstands pressure equivalent to a depth of 10 m. For more information, go to www.garmin.com/waterrating.

| | |
|--|--|
| Operating temperature range (battery power, cold start) ² | From 0 to 40° C (from 32 to 104° F) |
| Operating temperature range (battery power, warm start) ² | From -20 to 40° C (from -4 to 104° F) |
| Charging temperature range | From 0 to 40° C (from 32 to 104° F) |
| Input voltage | 5 V, 2 A |
| Wireless frequencies and protocols | 2.4 GHz Wi-Fi 2.4 GHz ANT+ 2.4 GHz Bluetooth |

NOTICE

The device is not water resistant when either the battery door or side door is open.

Low Temperature Performance Tips

- The battery life and video recording performance of the camera are reduced at low temperatures. If the battery temperature is below 0° C (32° F), the battery may not provide enough power for the camera to record video, and the camera may turn off.
- You can improve the camera's battery life and video recording performance in low temperatures by storing the camera battery at room temperature until you are ready to use it. If the battery is at room temperature when you start recording, heat generated by the camera operation prevents the battery from becoming too cold, and the camera operates and records video in temperatures as low as -20° C (-4° F).
- You can store the battery indoors, in a heated vehicle, or in an empty, interior clothing pocket to keep it at room temperature. If the camera turns off due to a cold battery, you can place the battery in an empty pocket or in a room-temperature environment to warm it.

WARNING

Do not place the battery in a pocket with other objects, especially sharp or metal objects. Other objects may damage the battery and may present a risk of damage to the device, fire, chemical burn, electrolyte leak, and/or injury.

- If you turn off the camera for a long period of time in a low-temperature environment, you should remove the battery and keep it at room temperature until you are ready to use the camera again.

Viewing Regulatory and Compliance Information

From the **About** menu, select ► > **Regulatory Info**.

Device Care

NOTICE

Avoid contact with chemical cleaners, solvents, gasoline, oil, insect repellents, or sunscreen. These chemicals can damage plastic components and finish.

Thoroughly rinse the device with fresh water as soon as possible after exposure to chlorine, salt water, sunscreen, cosmetics, alcohol, or other harsh chemicals. Prolonged exposure to these substances can damage the plastic components and finish.

Do not store the device where prolonged exposure to extreme temperatures can occur, because it can cause permanent damage.

² The operating temperature range is based on the default camera settings. Several factors may impact the operating temperature range, including the mount configuration, video settings, and Wi-Fi settings. Performance in cold environments is improved by starting the camera operation using a battery that has been stored at room temperature (*Low Temperature Performance Tips*, page 16).

Water Exposure and Rating

When the battery door and side door are closed and latched, the device has a water rating of 1 ATM.¹

When using your device near liquids, you must observe these considerations and care tips to help preserve the water rating and avoid damage to the camera.

- The device is not water resistant when either the battery door or side door is open.
- You should keep the door gaskets and sealing surfaces clean and free of dust and debris.
- The device is not water resistant if the lens, lens retainer, or lens gasket are damaged or removed, or if the lens retainer is not fully tightened.

If you replace the cover lens, you must ensure the lens gasket and sealing surfaces are undamaged, clean, and free of dust and debris, and you must verify the lens retainer is fully tightened ([Replacing a Cover Lens](#), page 17).

- You should thoroughly rinse the device as soon as possible after exposure to saltwater or chlorinated water.

Cleaning the Device

- 1 Wipe the outer casing of the device with a soft, non-scratch cloth dampened with water.
- 2 Wipe the device dry.

Replacing a Cover Lens

If either of the cover lenses become scratched or damaged, you can replace them. The VIRB 360 lens replacement kit includes two cover lenses, two gaskets, and two lens retainer rings. Go to garmin.com/virb to purchase a lens replacement kit.

- 1 Turn the lens retainer ring counter-clockwise to unlock it.



- 2 Remove the lens retainer ring, cover lens ①, and gasket ②.



- 3 Wipe the gasket groove ③ with a lint-free cloth.
- 4 Verify the new cover lens, new gasket, and the gasket groove are clean and free of dust or debris.

NOTICE

The camera may not be water resistant if the gasket and sealing surface are not clean and free of dust or debris. Dust or debris may damage the gasket or prevent the gasket from sealing properly.

- 5 Place the new gasket, cover lens, and lens retainer ring on the camera.
- 6 Rotate the lens retainer ring clockwise until the marks ④ on the camera and the lens retainer ring are aligned.

¹ The device withstands pressure equivalent to a depth of 10 m. For more information, go to www.garmin.com/waterrating.



NOTICE

The camera is not water resistant when the lens retainer ring is not fully tightened.



Symbol Definitions

These symbols may appear on the device or accessory labels.

| | |
|---|--|
|  | Fuse. Indicates a fuse specification or location. |
|  | WEEE disposal and recycling symbol. The WEEE symbol is attached to the product in compliance with the EU directive 2012/19/EU on Waste Electrical and Electronic Equipment (WEEE). It is intended to deter the improper disposal of this product and to promote reuse and recycling. |
|  | Hot surface. The surface indicated by this mark may become hot during device operation. |

Troubleshooting

My camera does not turn on

- If the camera is connected to external power and the top status LED is either off or solid red, hold **POWER** to turn on the camera.

The camera does not turn on automatically when connected to external power. When the top status LED is solid red, the camera is in charging mode. When the top status LED is off, the battery is fully charged, and the camera is off.

- If the camera turns off due to a high temperature warning, wait for the camera to cool down, and move to a lower-temperature area or disable unneeded features.

Some features, such as 5.7K recording mode, require more processing power and reduce the camera's ability to operate in high-temperature environments. Using default settings, the camera operates in temperatures of up to 40°C (104°F).

- Verify the battery is installed correctly ([Installing the Battery](#), page 1).
- Fully charge the battery ([Charging the Battery](#), page 1).
- Verify the battery temperature is at least 0°C (32°F) ([Low Temperature Performance Tips](#), page 16).

My camera feels warm while it is operating

It is normal for the camera to feel warm during typical use, especially while it is recording high-resolution video or transmitting a Wi-Fi signal.

Some G-Metrix data is missing

Some G-Metrix data requires you to enable or pair sensors, or use specific accessories. Some G-Metrix data may not be available for all recording situations or when you are not recording video.

- Enable GPS ([System Settings](#), page 14), and go to an area with a clear view of the sky.
Location, speed, distance, and altitude data require a GPS signal.
- Connect additional ANT+ sensors ([Pairing ANT+ Sensors](#), page 14).

Some data is available only when a compatible ANT+ sensor is connected.

My video recordings do not look smooth

- If video recordings appear shaky, use the VIRB Edit application or the Garmin VIRB mobile app to apply image stabilization to the video.
- If video recordings stutter or skip frames, install a recommended, high-speed memory card.
For more information about recommended memory cards, go to garmin.com/VIRBcards.
- Verify your playback device or software is capable of playing the video smoothly.
For example, if you are playing a 360-degree video, verify the playback device or software is capable of playing 5K video and 360-degree video. The VIRB Edit application is recommended for video playback.
- Transfer the video to your computer or playback device.
Some memory card readers do not read data quickly enough to play high-resolution video directly from the memory card.
- Use the VIRB Edit application to play and edit video.
Go to garmin.com/VIRBEdit to download the VIRB Edit application.

My device turns off when I stop recording video

If you turn on the device by moving the recording switch forward, the device turns off when you move the recording switch backward. This allows you to maximize battery life by turning off the device when it is not recording (*Turning the Camera On and Off Using the Recording Switch*, page 2).

Extending the Battery Life

- Disable Wi-Fi.
- Enable **Auto-Off** in the system settings (*System Settings*, page 14).
- Turn the device on and off using the recording switch (*Turning the Camera On and Off Using the Recording Switch*, page 2).
- Disable ANT+, Wi-Fi, and remote wake-up when not in use.

Index

Symbols

360-degree video [4](#), [11](#)

A

accessories [14](#)
ANT+ sensors [2](#), [6](#), [14](#)
 forgetting [14](#)
 pairing [14](#)

B

battery [14–16](#)
 charging [1](#)
 installing [1](#)
 life [16](#), [18](#)
Bluetooth technology [2](#), [14](#)
broadcasting video [5](#), [8](#)

C

cadence [6](#)
camera, settings [2](#), [9](#), [14](#)
cleaning the device [16](#), [17](#)
customizing the device [14](#)

D

deleting, all user data [14](#)

E

elevation [6](#)

G

G-Metrix [6](#)
Garmin Express [16](#)
 updating software [15](#)
Garmin VIRB app [7](#), [11](#), [12](#)
 connecting [7](#)
GPS [2](#), [6](#)
 settings [2](#), [14](#)

H

heart rate [6](#)

I

icons [2](#)

L

language [14](#)
lens, replacing [17](#)
lens mode [4](#)
live streaming video [5](#), [8](#)

M

maps, updating [15](#)
memory card [1](#), [15](#)
microphone [5](#)
 connecting [14](#)
microSD card. *See* memory card
mobile app [7](#), [11](#), [12](#)
mounts [3](#)
 removing [3](#)
 tripod [3](#)
multiple cameras [12](#), [13](#)

P

photos [9](#)
 night [10](#)
 self timer [5](#)
 settings [6](#), [8](#)
 taking [5](#)
 time-lapse [10](#)
 Travelapse [10](#)
 viewing [11](#)
playing video [11](#)
power (force) [6](#)
power key [2](#)

R

recording video [4](#)
remote control [13](#), [15](#)

S

settings [8](#)
software
 updating [14](#), [15](#)
 version [14](#)
spatial audio [5](#)
specifications [16](#)
speed [6](#)
system settings [8](#), [14](#)

T

temperature [6](#), [16](#)
time-lapse, photos [10](#)
tones [14](#)
tracks [6](#), [14](#)
Travelapse, photos [10](#)
troubleshooting [17](#), [18](#)

U

unit ID [14](#)
updating
 maps [15](#)
 software [15](#)

V

video [6](#)
 360-degree [4](#)
 broadcasting [5](#), [8](#)
 editing [11](#), [14](#)
 loop [9](#)
 output [5](#)
 playing [11](#)
 recording [2](#), [4](#), [8](#), [9](#), [15](#)
 settings [2](#), [4](#), [5](#), [8](#)
 stitching [4](#)
 time lapse [4](#)
VIRB app [13](#)
 connecting [12](#)
 multiple cameras [12](#)
VIRB mobile app [15](#)
virtual reality [11](#)
voice control [6](#)
 tips [6](#)
VR headset [11](#)

W

water rating [16](#), [17](#)
Wi-Fi [2](#), [12](#), [15](#)
 connecting [11](#), [12](#), [15](#)

